

essentials

Including the premium+ range



Affordable quality in the kitchen

The essentials collection...

The kitchen is the hub of every home, a place to relax, eat and cook. Our Essentials range has been carefully assembled with a vast array of excellent appliances making sure that every base is covered.

The best thing about the Essentials range is that its all available at an affordable price, meaning you don't need to compromise quality. So for all your kitchen needs, Essentials has the ideal product for you.



03 premium+ single ovens

04 premium+ compacts

05 premium+ hoods

06 premium+ ceiling & canopy hoods

07 premium+ downdraft & chandelier hoods

08 premium+ venting hobs

10 premium+ flexi induction hobs

11 premium+ induction hobs & domino hobs

12 premium+ gas hobs

14 premium+ refrigeration & wine cabinets

15 essentials wine coolers

16 essentials ovens

18 essentials induction hobs

19 essentials ceramic hobs

20 gas hobs

22 essentials hoods

26 essentials hoods & splashbacks

27 essentials microwaves

28 essentials refrigeration

29 essentials dishwashers & laundry

PPS60MF

60cm Multifunction Single Oven

- Energy rating A
- 70 litre capacity
- 8 functions plus light
- Easy clean enamel
- Jog switch and push button controls
- Digital timer
- 1 shelf
- Double glazed door
- Black with Stainless Steel

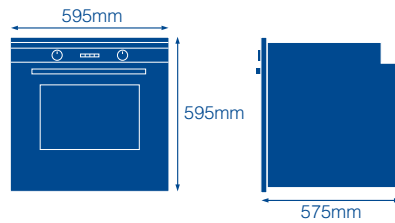

PPS60PYMF

60cm Multifunction Pyrolytic Single Oven

- Energy rating A
- 70 litre capacity
- 9 functions plus light
- Pyrolytic cleaning
- Jog switch and push button controls
- Digital timer
- 1 shelf
- Quadruple glazed door
- Black with Stainless Steel

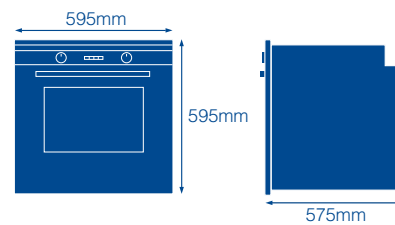

PPS60MFCOP

60cm Multifunction Single Oven

- Energy rating A
- 58 litre capacity
- 12 functions plus light
- Touch control
- LED programmer
- 1 shelf
- Grill pan set
- Double glazed door
- Black with Copper trim

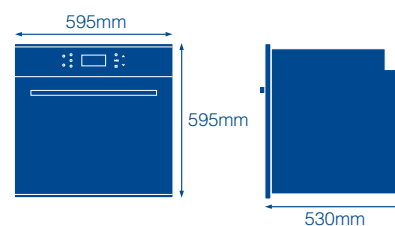

PPS45MWC.1

45cm Combination Microwave & Grill

- 44 litre capacity
- Auto programmes
- Defrost function
- Quick start
- 900W microwave power, 1750W grill power, 1750W convection power
- LED white display
- 16 amp connection
- 360mm glass turntable
- Black with Stainless Steel

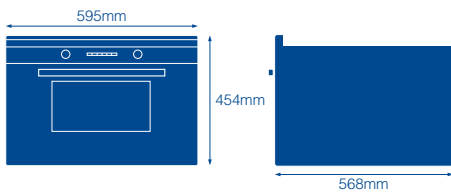

PPS14WDBK

14cm Handleless Warming Drawer

- 6 temperature settings 40-80°C
- 6 place settings
- Touch control
- 25kg maximum load
- 22 litre capacity
- Anti-slip mat
- Black Glass

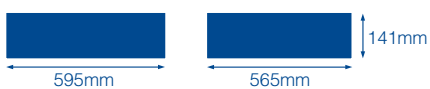

PPDANG60B

60cm Angled Designer Chimney Hood

- 3 fan speeds
- Energy rating A
- 2 x 1.5W LED lights
- Extraction rate 620.3m3/hr
- Touch control
- 2 aluminium grease filters
- Black



Also available



PPDANG60W

White 60cm Angled Designer Chimney Hood

ESSCF12 Optional Carbon Filter

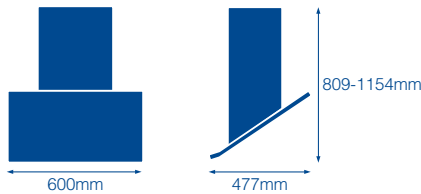

PPDANG90B

90cm Angled Designer Chimney Hood

- 3 fan speeds
- Energy rating A
- 2 x 1.5W LED lights
- Extraction rate 620.3m3/hr
- Touch control
- 2 aluminium grease filters
- Black



Also available



PPDANG90W

White 90cm Angled Designer Chimney Hood

ESSCF12 Optional Carbon Filter

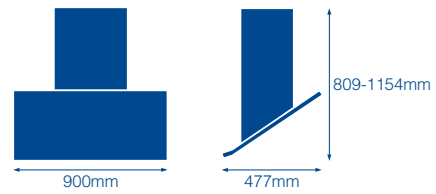

PPRUN60COP

60cm Angled Runway Hood

- Touch control
- 3 speeds
- Energy rating B
- 60dB
- Extraction rate 371.5m3/hr
- 2 x 1.5W LED lights and 3W decorative LEDs
- 1 aluminium grease filter
- Black Glass with Copper trim



ESSCF11 Optional Carbon Filter

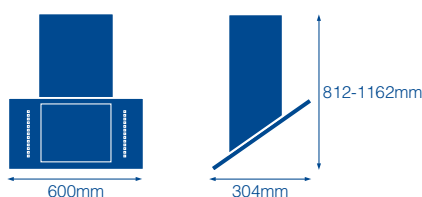

PPANG60COP

60cm Angled Chimney Hood

- 3 speeds
- 56dB
- Energy rating B
- 2 x 1.5W LED lights
- Extraction rate 371.5m3/hr
- Touch control
- 1 aluminium grease filter
- Black with Copper trim



ESSCF11 Optional Carbon Filter

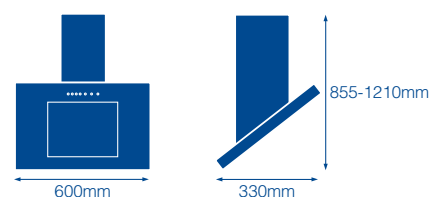

PPCE110SS

110cm Ceiling Extractor

- 3 fan speeds
- Energy rating A
- 4 x 2.5W LED lights
- Extraction rate 991.5m³/hr
- Touch control / remote control
- Stainless Steel

ESSCF19 Optional Carbon Filter

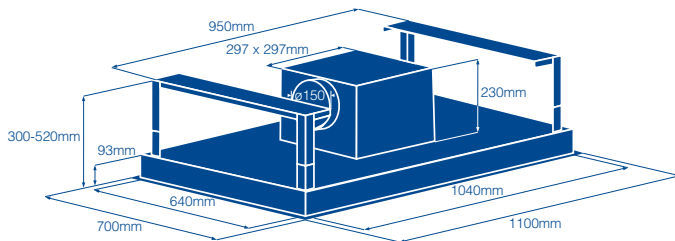

6"

Also available

PPCE110BK

Black 110cm Ceiling Extractor



PPCE110WH

White 110cm Ceiling Extractor



PPCAN52BK

52cm Glass Canopy Hood

- 3 fan speeds
- Energy rating B
- 2 x 1.5W LED lights
- Extraction rate 650m³/hr
- Touch control
- 1 aluminium grease filter
- Black Glass



Also available

PPCAN52WH.1

White 52cm Glass Canopy Hood



6"

ESSCF19 Optional Carbon Filter

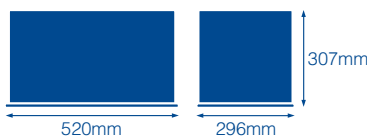

PPCAN75BK.1

75cm Glass Canopy Hood

- 3 fan speeds
- Energy rating B
- 2 x 1.5W LED lights
- Extraction rate 650m³/hr
- Touch control
- 1 aluminium grease filter
- Black Glass



Also available

PPCAN75WH

White 75cm Glass Canopy Hood



6"

ESSCF19 Optional Carbon Filter

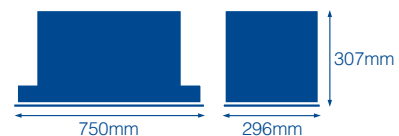

PPDD60SS.1

60cm Downdraft Extractor Hood

- Electronic touch control • 4 speeds • Extraction rate 430.1m3/hr
- 2 x LED lights • 1 aluminum grease filter • 67 dB noise level



Please note this product cannot be used with a gas hob



Requires ESSCF13 Carbon Filter & 3 ESSRWIRE Retaining Wires for recirculating

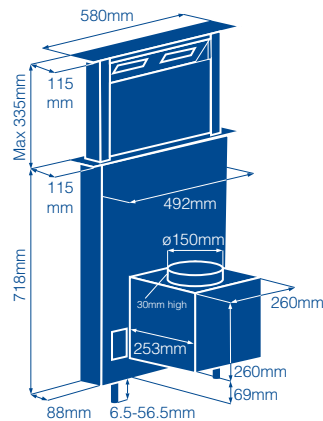

Also available

PPDD60WH

White 60cm Downdraft Extractor Hood



PPDD90SS.2

90cm Downdraft Extractor Hood

- Blue touch control display • 4 speeds • Extraction rate 538.5m3/hr
- 2 x LED lights • 1 aluminum grease filter • 67 dB noise level



Please note this product cannot be used with a gas hob



This product is designed to be installed into an Island with a 900mm or 1000mm worktop

Requires ESSCF14 Carbon Filter & 4 ESSRWIRE Retaining Wires for recirculating

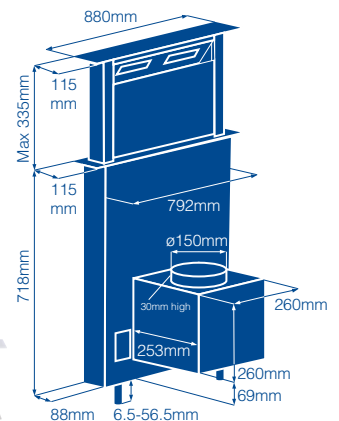

Also available

PPDD90WH

White 90cm Downdraft Extractor Hood



PPCHANDSS/COP

35cm Chandelier Hood

- 3 fan speeds
- Energy rating C
- 2 x 1W LED lights
- Extraction rate 557.5m3/hr
- Electronic button control
- 1 aluminium grease filter
- Supplied with 2 carbon filters
- Recirculatory only
- Stainless Steel or Copper

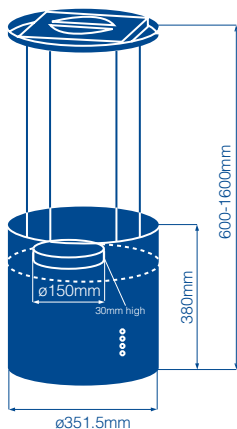

PPIHFX77DDG

77cm Flex Induction Venting Hob

- Energy rating A
- 4 zones including 2 flex zones
- Hob timer
- Heat indicator light
- 9 hob power levels
- Keep warm, Boost and Pause functions
- Child safety lock
- Touch control
- Extraction rate 579m3/hr
- 6 fan speeds
- 67dB noise level
- Ventilation required
- Grease filter
- 32 amp connection
- Convert hob to recirculation with PPRCKIT kit listed below, includes a washable carbon filter
- Hob must be installed into a 80cm or 100cm Base unit
- 150mm / 6" ducting kit required to duct hob out
- Black Glass with Gunmetal Trim & Grille

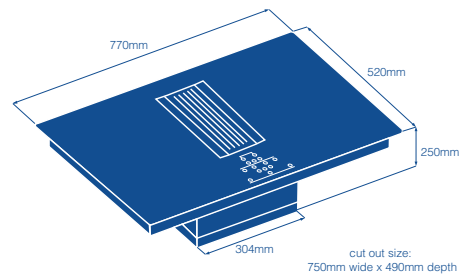

Minimum worktop depth 25mm PPRCKIT Recirculation Kit also available

PPIHFX77DDC

77cm Flex Induction Venting Hob

- Energy rating A
- 4 zones including 2 flex zones
- Hob timer • Heat indicator light
- 9 hob power levels
- Keep warm, Boost and Pause functions
- Child safety lock
- Touch control
- Extraction rate 579m3/hr
- 6 fan speeds
- 67dB noise level
- Ventilation required
- Grease filter
- 32 amp connection
- Convert hob to recirculation with PPRCKIT kit listed below, includes a washable carbon filter
- Hob must be installed into a 80cm or 100cm Base unit
- 150mm / 6" ducting kit required to duct hob out
- Black Glass with Copper Trim & Grille

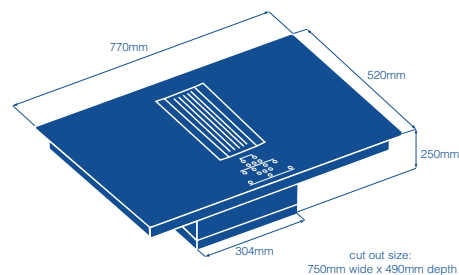

Also available

PPIHFX77DDS

Black Glass with
Stainless Steel Trim & Grille



Minimum worktop depth 25mm PPRCKIT Recirculation Kit also available

PPIH70DD

70cm Induction Venting Hob

- 4 cooking zones
- Front touch controls
- 9 power levels
- Timer
- Heat indicator light
- Child safety lock
- 3 fan speeds
- Extraction rate 504m3/hr
- Grease filter
- Carbon filter sheet
- 40 amp connection
- 2 filter fixing bars with iron wire
- Can also be ducted
- Black Glass with Black, Stainless Steel and Copper extraction grilles included

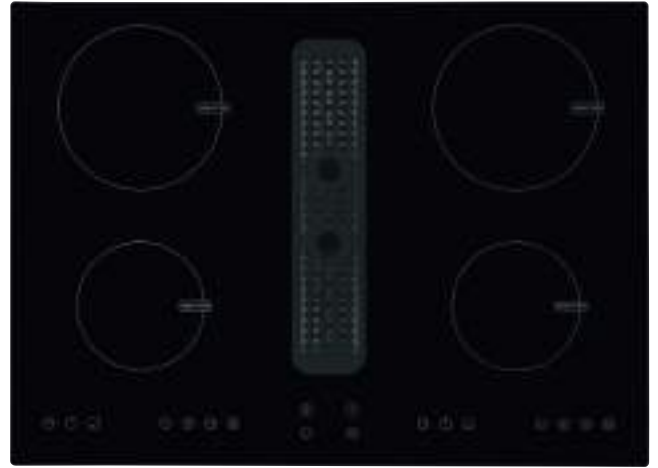
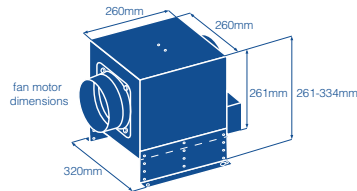
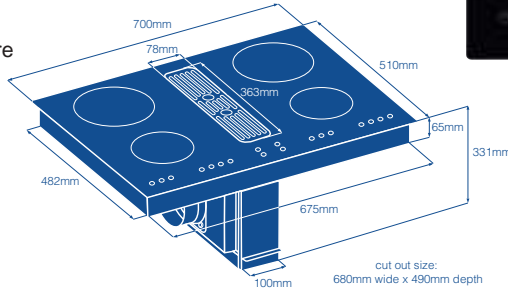

Alternative Stainless Steel and Copper extraction grilles included

6"

Minimum worktop depth 20mm

PPIHFZ277DD

77cm Flex Induction Venting Hob

- Energy rating A
- 4 zones including 2 flex zones
- LED Touch Sense display
- Extraction rate 579m3/hr
- 67dB noise level
- Ventilation required
- Metallic grease filter
- 32 amp connection
- Convert hob to recirculation with PPRCKIT kit listed below, includes a washable carbon filter
- Hob must to be installed into a 80cm or 100cm Base unit
- 150mm / 6" ducting kit required to duct hob out
- Black Glass with designer Black Grille

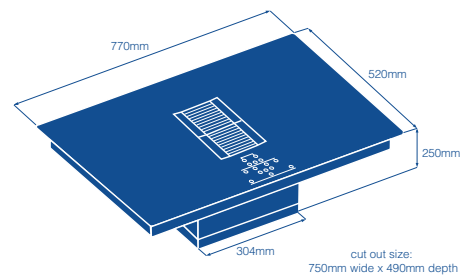
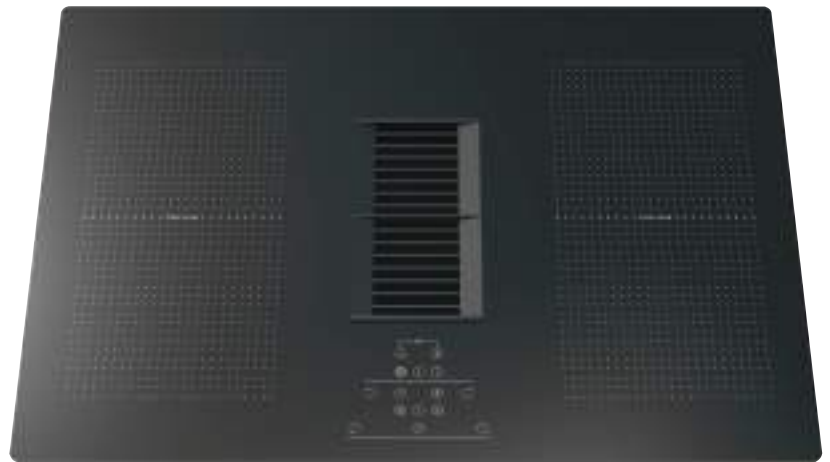

6"

Minimum worktop depth 25mm

PPRCKIT Recirculation Kit also available

PPIHFLEX60

60cm Flexi Zone Induction Hob

- 4 flexible zones
- Timer • Heat indicator light
- Touch control
- 9 power levels
- Keep warm function
- Boost function
- Child safety lock

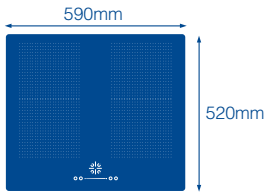

cut out size:
565mm wide x 495mm depth



PPIHFX60COP

60cm Flexi Zone Induction Hob

- 4 flexible zones • Timer • Heat indicator light
- Slider touch control • 9 power levels
- Keep warm function
- Boost function
- Pause function
- Child safety lock
- Black Glass with Copper Trim

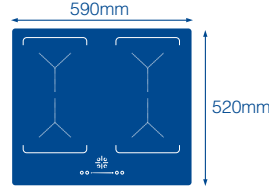

cut out size:
565mm wide x 495mm depth



PPIHFLEX90

90cm Flexi Zone Induction Hob

- 5 cooking zones
- 4 flexible zones
- Timer • Heat indicator light
- Touch control
- 9 power levels
- Keep warm function
- Boost function
- Child safety lock

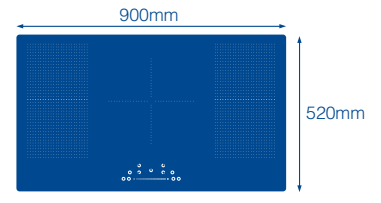

cut out size:
775mm wide x 495mm depth

PPIHFX90COP

90cm Flexi Zone Induction Hob

- 5 cooking zones • 2 flexible zones
- Timer • Heat indicator light
- Slider touch control
- 9 power levels
- Keep warm function
- Boost function
- Pause function
- Child safety lock
- Black Glass with Copper Trim

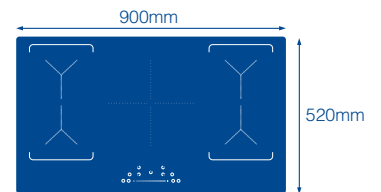

cut out size:
875mm wide x 495mm depth

PPIHLINEA/W

90cm Panoramic Linea Induction Hob

- 4 cooking zones
- Timer
- Heat indicator light
- Front touch control
- 9 power levels
- Keep warm function
- Boost function
- Child safety lock
- Black or White Glass

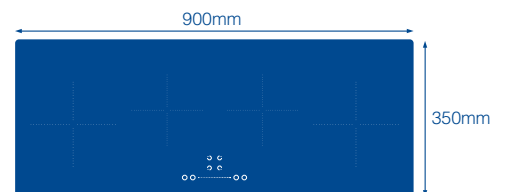

cut out size:
875mm wide x 325mm depth

PPIHTFT60

60cm TFT Flexi Zone Induction Hob

- 4 cooking zones
- 2 flexible zones
- Timer • Heat indicator light
- RF Connectivity
- 5 inch TFT FHD touch screen
- 9 power levels plus boost
- Keep warm function
- Boost function
- Pause function
- Child safety lock

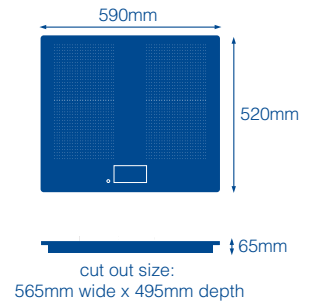

PPIHTFT80

80cm TFT Flexi Zone Induction Hob

- 4 cooking zones
- 1 flexible zone
- Timer • Heat indicator light
- RF Connectivity
- 5 inch TFT FHD touch screen
- 9 power levels plus boost
- Keep warm function
- Boost function
- Pause function
- Child safety lock

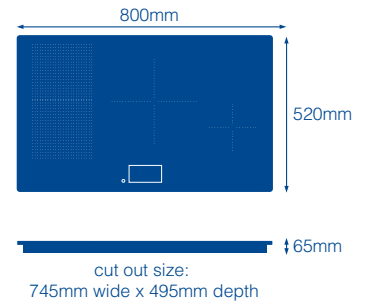

PPIHTFT90

90cm TFT Flexi Zone Induction Hob

- 5 cooking zones
- 2 flexible zone
- Timer • Heat indicator light
- RF Connectivity
- 5 inch TFT FHD touch screen
- 9 power levels plus boost
- Keep warm function
- Boost function
- Pause function
- Child safety lock

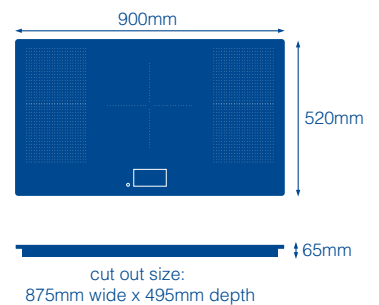
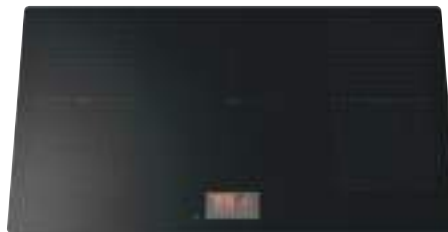

PPCH30BV.1

30cm Domino Ceramic Hob

- 2 zones
- Front touch controls
- Heat indicator light
- 9 power levels
- Timer
- Child safety lock
- 16 amp connection
- Black Glass

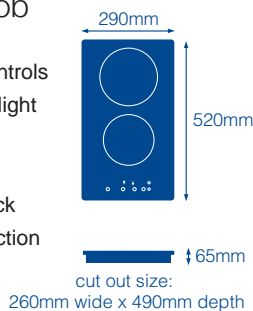

PPIH30.2

30cm Domino Induction Hob

- 2 zones
- Front touch controls
- Heat indicator light
- 9 power levels
- Boost function
- Child safety lock
- Timer
- 16 amp connection
- Black Glass

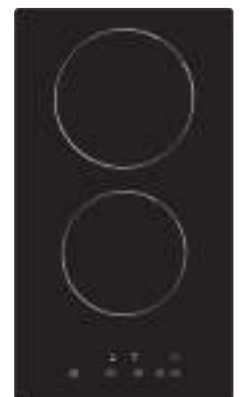
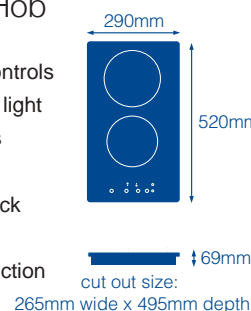

PPS60GHSS

60cm Gas Hob

- 4 burners
- Cast iron pan supports
- Auto ignition
- LPG kit supplied
- Stainless Steel

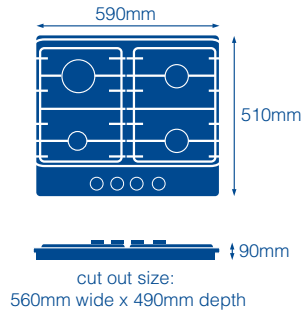

PPS70GHSS

75cm Gas Hob

- 5 burners
- Cast iron pan supports
- Auto ignition
- LPG kit supplied
- Stainless Steel

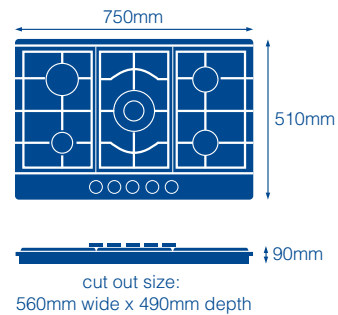

PPGHLINEA

96cm Linea Gas on Glass Hob

- 4 burners • Auto ignition
- Dual burner
- Cast iron pan supports
- Flame safety device
- LPG convertible with jets included
- Black Glass with Stainless Steel

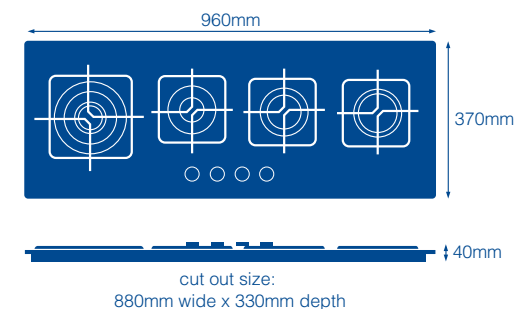

PPGH60GBKA

60cm Gas on Glass

- 4 burners including wok burner
- Automatic ignition
- Flame safety device
- Cast iron pan stands
- Black Glass

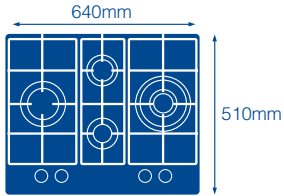

PPGH60GBK.1

60cm Gas on Glass Hob

- 4 burners
- Automatic ignition
- Flame safety device
- Cast iron pan stands
- Black Glass

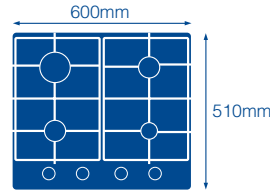

PPGH70GBK.1

70cm Gas on Glass Hob

- 5 burners
- Automatic ignition
- Flame safety device
- Cast iron pan stands
- Black Glass

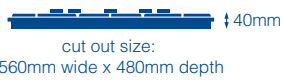
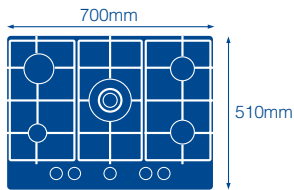

PPGH90GBK.1

90cm Gas on Glass Hob

- 5 burners
- Automatic ignition
- Flame safety device
- Cast iron pan stands
- Black Glass

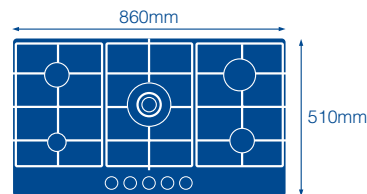

PPGH30SBK

30cm Gas on Glass
Single Burner Domino Hob

- Automatic ignition
- Cast iron pan stands
- Flame safety device
- LPG convertible with jets included
- Black Glass

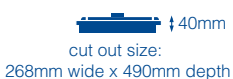
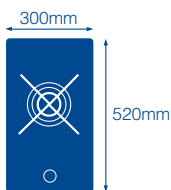

PPGH30TBK

30cm Gas on Glass
Twin Burner Domino Hob

- Automatic ignition
- Cast iron pan support
- Flame safety device
- LPG convertible with jets included
- Black Glass

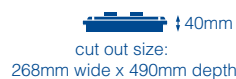
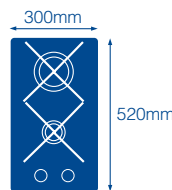

PPTLF

Built In Tall Larder Fridge

- 300 litre net capacity
- Electronic controls • Energy rating F
- LED light
- 4 shelves and 2 crispers
- Reversible door • Sliding hinge

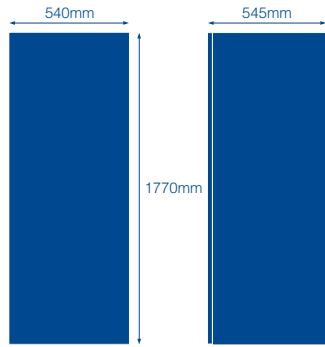

PPTFZ

Built In Frost Free Tall Freezer

- 197 litre net capacity
- Electronic controls • Energy rating F
- 4* freezer rating • 7 drawers
- Reversible door
- Sliding hinge

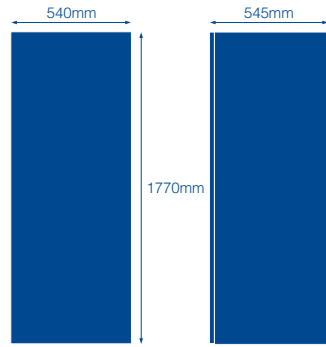

PPWC300GM

Built In 30cm Wine Cabinet

- Holds 20 bottles of wine
- Compressor technology
- Adjustable digital thermostat
- Temperature range 5 - 22°C
- Energy rating G • White LED interior light
- LED display • Touch screen control
- Auto defrost • Wooden shelves
- 42dB • Gunmetal front with Black sides

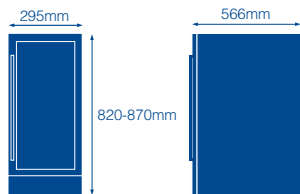

PPWC300BK

Built In 30cm Wine Cabinet

- Holds 20 bottles of wine
- Compressor technology
- Adjustable digital thermostat
- Temperature range 5 - 18°C
- Energy rating G • White LED interior light
- LED display • Touch screen control
- Auto defrost • Wooden shelves
- 39dB • Black

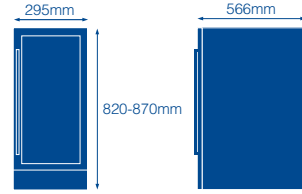

PPWC300SS

Built In 30cm Wine Cabinet

- Holds 20 bottles of wine
- Compressor technology
- Adjustable digital thermostat
- Temperature range 5 - 18°C
- Energy rating G • White LED interior light
- LED display • Touch screen control
- Auto defrost • Wooden shelves
- 39dB • Stainless Steel

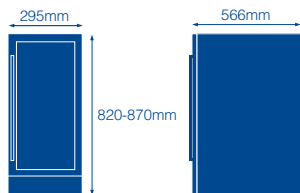

PPWC460

Built In 46cm High Wine Cabinet

- Holds 24 bottles of wine
- Compressor technology
- Adjustable digital thermostat
- Temperature range 5 - 22°C
- Energy rating G
- White LED interior light
- Blue LED display
- Auto defrost
- Wooden shelves • 39dB
- Stainless Steel

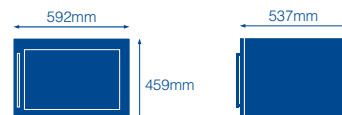

ESSWC150SS

15cm Wine Cooler

- Holds 7 bottles of wine
- Energy rating G
- Compressor technology
- Temperature range 5 - 22°C
- LED soft interior light
- LED temperature display
- Auto defrost
- Wooden shelves
- Stainless Steel



ESSWC150BK

15cm Wine Cooler

- Holds 7 bottles of wine
- Energy rating G
- Compressor technology
- LED soft interior light on/off switch
- Chrome shelves
- Adjustable feet
- Black Glass with Stainless Steel handle



ESSWC300SS

30cm Wine Cooler

- Holds 18 bottles of wine
- Energy rating G
- Compressor technology
- Temperature range 5 - 22°C
- LED soft interior light
- LED temperature display
- Auto defrost
- Wooden shelves
- Stainless Steel



ESSWC300BK

30cm Wine Cooler

- Holds 18 bottles of wine
- Energy rating G
- Compressor technology
- Adjustable thermostat temperature range 5 - 22°C
- Soft interior light on/off switch
- Chrome shelves • Adjustable feet
- Black Glass with Stainless Steel handle



NEW ESSWC300BK.1 with wooden shelves coming soon

ESSWC600SS

60cm Wine Cooler

- Holds 46 bottles of wine
- Dual zone
- Energy rating G
- Compressor technology
- Soft interior light
- LED temperature display
- Auto defrost
- Wooden shelves
- Stainless Steel



ESSWC600BK

60cm Wine Cooler

- Holds 46 bottles of wine
- Dual zone • Energy rating G
- Compressor technology
- Adjustable thermostat temperature range 5 - 22°C
- LED Soft interior light on/off switch
- Chrome shelves • Adjustable feet
- Black Glass with Stainless Steel handle



NEW ESSWC600BK.1 with wooden shelves coming soon

ESSWCTZ60SS

60cm 2 Door Wine Cooler

- Holds 36 bottles of wine
- Dual zone
- Energy rating G
- Compressor technology
- LED interior light
- LED temperature display
- Auto defrost
- Wooden shelves
- Stainless Steel



ESSWCTZ60BK.1

60cm 2 Door Wine Cooler

- Holds 36 bottles of wine
- Dual zone
- Energy rating G
- Compressor technology
- Interior light
- LED temperature display
- Auto defrost
- Wooden shelves
- Black Glass with Stainless Steel handle



ESS60SS

Built In Fan Oven

- Energy rating A
- 58 litre capacity
- Fan Oven
- Full grill
- Fan assisted grill
- Timer
- 1 shelf and grill pan set
- 13 amp connection
- Black with Stainless Steel

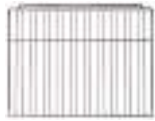

Also available
ESSSHELF
Oven Shelf Accessory

ESS60BK

Built In Fan Oven

- Energy rating A
- 58 litre capacity
- Fan Oven
- Full grill
- Fan assisted grill
- Timer
- 1 shelf and grill pan set
- 13 amp connection
- Black Glass with Stainless Steel

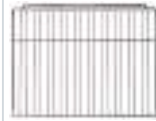

Also available
ESSSHELF
Oven Shelf Accessory



ESS61SS

Built In Electric Oven

- Energy rating A
- 58 litre capacity
- Fan Oven
- Full grill
- Fan assisted grill
- Digital electronic timer
- 1 shelf and grill pan set
- 13 amp connection
- Black with Stainless Steel

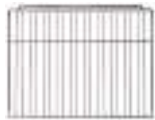

Also available
ESSSHELF
Oven Shelf Accessory

ESS61BK

Built In Fan Oven

- Energy rating A
- 58 litre capacity
- Fan Oven
- Full grill
- Fan assisted grill
- Digital electronic timer
- 1 shelf and grill pan set
- 13 amp connection
- Black Glass & Stainless Steel

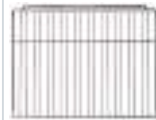

Also available
ESSSHELF
Oven Shelf Accessory



ESS62SS

Built In Multifunction Oven

- Energy rating A
- 58 litre capacity
- 8 functions, defrost mode, double grilling, double grilling with fan, conventional oven, true fan, bottom heat, lower heat with fan and fan assisted
- Timer
- 1 shelf and grill pan set
- 13 amp connection
- Black with Stainless Steel



Also available
ESSSHELF
Oven Shelf Accessory

ESS62BK

Built In Multifunction Oven

- Energy rating A
- 58 litre capacity
- 8 functions, defrost mode, double grilling, double grilling with fan, conventional oven, true fan, bottom heat, lower heat with fan and fan assisted
- Timer
- 1 shelf and grill pan set
- 13 amp connection
- Black Glass with Stainless Steel



Also available
ESSSHELF
Oven Shelf Accessory



ESS50SS

Built In Fan Oven

- Energy rating A
- 51 litre capacity
- Fan oven
- Full grill
- 1 shelf and grill pan set
- 13 amp connection
- Black with Stainless Steel



ESS63SS

Built In Gas Oven

- 60 litre capacity
- Full gas oven
- Gas grill
- Natural gas only
- 1 shelf and grill pan set
- Black with Stainless Steel trim



ESS60WH

60cm Multifunction Oven

- Energy rating A
- 58 litre capacity
- 9 function electric oven
- Full grill
- Touch control timer
- 13 amp connection
- White Glass with Stainless Steel



ESS64SS

Built In Side Opening Oven

- Energy rating A
- 67 litre capacity
- 8 functions, true fan, bottom heat with fan, conventional oven, defrost, fan assisted grill, full grill, small grill and oven light
- Digital electronic timer
- Blue LED display
- 13 amp connection
- Black Glass with Stainless Steel



ESH90BK

Built In Double Oven

- A/A energy rating
- 40/65 litre capacity
- Main fan oven with 4 functions
- Top conventional oven with 4 functions
- LED full programmer
- Double-glazed removable door
- Enamelled baking tray with handle
- 3 safety shelves
- Grill pan
- Black with Stainless Steel



ESH70BK

Built Under Double Oven

- A/A energy rating
- 40/40 litre capacity
- Main fan oven with 4 functions
- Top conventional oven with 4 functions
- LED full programmer
- Double-glazed removable door
- Enamelled baking tray with handle
- 2 safety shelves
- Grill pan
- Black with Stainless Steel



ESSIH50TC

60cm Induction Touch Control Hob

- 4 cooking zones
- Front touch control
- Hot hob indicator light
- Digital power display, with 9 power settings
- Timer and Keep Warm functions
- Child safety lock
- 32 amp connection
- Matt Black Glass



This Hob has a Matt finish
This Hob is supplied without a cable

ESSI60TC.1

60cm Induction Touch Control Hob

- 4 cooking zones
- Front touch control
- Hot hob indicator light
- Digital power display with 9 power settings
- Timer and Boost functions
- Child safety lock
- 32 amp connection
- Black Frameless



ESSIH60P

60cm Induction Hob

- 4 cooking zones
- Front touch control
- Hot hob indicator light
- 9 power levels
- Boost function • Timer
- Keep warm function
- Child safety lock
- 13 amp plug
- Black Glass



Connects to the



ESSRFCHIM60SS

Hood



This Hob has a Matt finish

ESSIH60W

60cm White Glass Induction Hob

- 4 Cooking Zones
- Timer
- Residual Heat Indicator
- Touch Control Operation
- Boost Function
- 32 amp connection
- White Glass



ESSIH60PBZ

60cm Induction Hob with Bridge Zone

- 4 cooking zones
- 1 x extended bridge zone
- Front touch control
- RF Connectivity
- Hot hob indicator light
- 9 power levels
- Boost function • Timer
- Keep warm function
- Child safety lock • 13 amp plug
- Matt Black Glass



Connects to the

ESSRFCHIM60SS

Hood

ESSIH77

77cm Induction Hob

- 4 cooking zones
- Slider touch control
- 9 power levels
- 4 boost function
- Keep warm function
- Timer
- Heat indicator light
- 32 amp connection required
- Black Glass



ESSIH90

90cm Induction Hob

- 5 cooking zones
- Touch control
- 9 power levels
- 5 boost function
- Keep warm function
- Timer
- Child safety lock
- Heat indicator light
- 45 amp connection required
- Black Glass



ESSC60R.2

60cm Ceramic Hob

- 4 cooking zones
- Side rotary control
- Hot hob indicator light
- Digital power display with 9 power settings
- Child safety lock
- Black Frameless

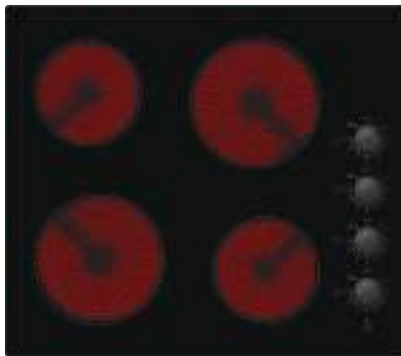

ESSC60TC.1

60cm Ceramic Touch Control Hob

- 4 cooking zones
- Front touch control
- Hot hob indicator light
- Digital power display, with 9 power settings
- Child safety lock
- 32 amp connection
- Black Frameless

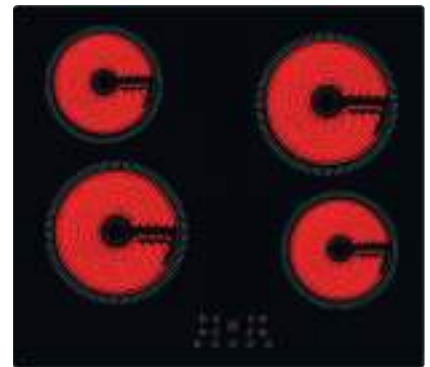

ESSC75TC

75cm Ceramic Touch Control Hob

- 4 cooking zones
- Front touch control
- Hot hob indicator light
- 9 power settings
- Timer
- Child safety lock
- Pause function
- 32 amp connection
- Black Frameless

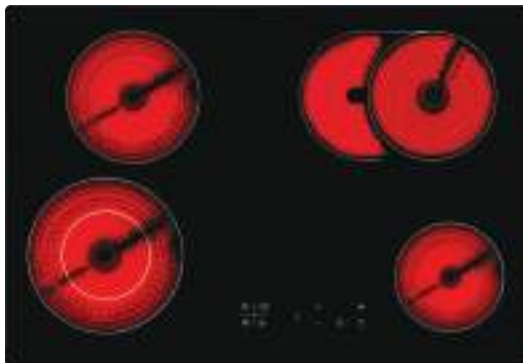

ESSC90TC.1

90cm Touch Control Ceramic Hob

- 5 cooking zones
- Front touch control
- Heat indicator light
- 9 power levels
- Timer
- Child safety lock
- 40 amp connection
- Black Glass



ESSG60E

60cm Gas Hob

- 4 burners
- Enamel pan supports
- Auto ignition
- LPG kit supplied
- Stainless Steel



ESSG60C

60cm Gas Hob

- 4 burners including 3kW wok burner
- Cast iron pan supports
- Auto ignition
- LPG kit supplied
- Stainless Steel

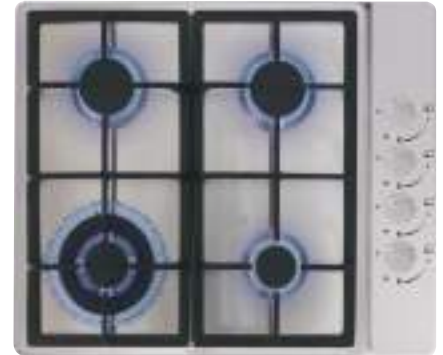

ESSG70C

70cm Gas Hob

- 5 burners including 3kW wok burner
- Cast iron pan supports
- Auto ignition
- LPG kit supplied
- Stainless Steel



ESSGGW64W

64cm Gas on White Glass Hob

- 4 burners including wok burner
- Automatic ignition
- Flame safety device
- LPG convertible with jets included
- Cast iron pan stands
- White Glass



Whilst stocks last

ESSGG60

64cm Gas on Glass Hob

- 4 burners
- Cast iron pan supports
- Auto ignition
- LPG kit supplied
- Diamond layout
- Black



ESSGGW60

60cm Gas on Glass Hob

- 4 burners including 3kW wok burner
- Cast iron pan supports
- Auto ignition
- LPG kit supplied
- Black



ESSGGW60W

60cm Gas on White Glass Hob

- 4 burners including wok burner
- Automatic ignition
- Flame safety device
- LPG convertible with jets included
- Pro Satin pan stands
- White Glass



ESSGGW60GM

60cm Gas on Glass Hob

- 4 burners including 3kW wok burner
- Cast iron pan supports
- Auto ignition
- LPG kit supplied
- Gunmetal Grey



ESSBLUE60BK

60cm Angled Hood with Blue LEDs

- Touch control
- 3 speeds
- Energy rating B
- 56dB
- Extraction rate 371.5m3/hr
- 2 x 1.5W Blue LED lights
- 1 aluminium grease filter
- Black Glass

5" or 6"

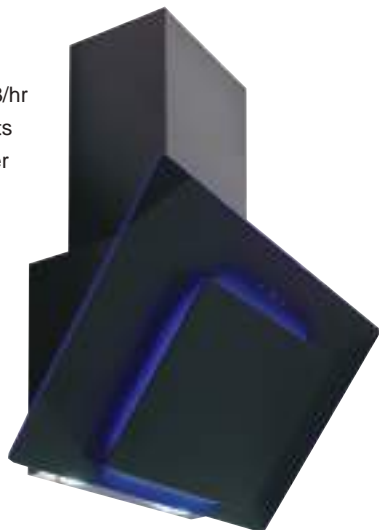

Also available

ESSBLUE70BK 70cm Angled Hood with Blue LEDs

- Black Glass

ESSBLUE90BK 90cm Angled Hood with Blue LEDs

- Black Glass

ESSCF11 Optional Carbon Filter

ESSCUR60BK

60cm Curved Angled Hood

- Touch control
- 3 speeds
- Energy rating B
- Extraction rate 371.5m3/hr
- 60dB
- 2 x 1.5W LED lights
- 1 aluminium grease filter
- Black Glass

5" or 6"



Also available

ESSCUR70BK 70cm Curved Angled Hood

- Black Glass

ESSCUR90BK 90cm Curved Angled Hood

- Black Glass

ESSCF11 Optional Carbon Filter

ESSANG60BK

60cm Black Angled Chimney Hood

- Touch control
- 3 speeds
- Energy rating B
- Extraction rate 371.5m3/hr
- 60dB
- 2 LED lights
- 1 aluminium grease filter
- Black with Stainless Steel Chimney

6"



Also available

ESSANG70BK 70cm Black Angled Hood

- Black

ESSANG90BK 90cm Black Angled Hood

- Black

ESSCF11 Optional Carbon Filter

ESSANG60WH

60cm White Angled Chimney Hood

- Touch control
- 3 speeds
- Energy rating B
- Extraction rate 371.5m3/hr
- 56dB
- 2 LED lights
- 1 aluminium grease filter
- White with Stainless Steel Chimney

5" or 6"



Also available

ESSANG70WH 60cm White Angled Hood

- White

ESSANG90WH 90cm White Angled Hood

- White

ESSCF11 Optional Carbon Filter

ESSANGP60SS

60cm Angled Hood

- Push button control
- 3 speeds
- Energy rating C
- Extraction rate 300m3/hr
- 2 x 1.5W LED lights
- 1 aluminium grease filter
- Stainless Steel Chimney with Black Steel and Glass



6"

ESSCF15 Optional Carbon Filter

ESSRUN90BK

90cm Angled Runway Hood

- Touch control
- 3 speeds
- Energy rating B
- 60dB
- Extraction rate 371.5m3/hr
- 2 x 1.5W LED lights and 3W decorative LEDs
- 1 aluminium grease filter
- Black Glass



5"

or

6"

Also available

ESSRUN60BK 60cm Angled Runway Hood

- Black Glass

ESSRUN70BK 70cm Angled Runway Hood

- Black Glass

ESSCF11 Optional Carbon Filter

ESSANGP60BK

60cm Angled Hood

- Push button control
- 3 speeds
- Energy rating B
- Extraction rate 371.5m3/hr
- 2 x 1.5W LED lights
- 1 aluminium grease filter
- Black Glass



6"

ESSCF11 Optional Carbon Filter

ESSCE90WH

90cm Ceiling Hood

- Remote control
- 3 speeds
- Energy rating A
- Extraction rate 614m3/hr
- 66 dB
- LED Halo lighting
- Suitable to recirculation / vent
- White with Grey Glass



6"

ESSCF23 Optional Carbon Filter Pack of 2

ESSANGP60

60cm Angled Hood

- Push button control
- 3 speeds
- Energy rating C
- Extraction rate 300m3/hr
- 2 x 1.5W LED lights
- 1 aluminium grease filter
- Stainless Steel



6"

ESSCF15 Optional Carbon Filter

ESSCHIM60SS.2

60cm Chimney Hood

- Push button control
- 3 speeds
- Energy rating C
- Extraction rate 308m3/hr
- 63.5dB
- 2 LED lights
- 2 aluminium grease filters
- Stainless Steel



Also available

ESSCHIM70SS.1 70cm Chimney Hood

- Stainless Steel

ESSCHIM90SS.1 90cm Chimney Hood

- Stainless Steel

ESSCF15 Optional Carbon Filter Pack of 2



ESSCHIM60BK.1

60cm Chimney Hood

- Push button control
- 3 speeds
- Energy rating C
- Extraction rate 308m3/hr
- 63.5dB
- 2 LED lights
- 2 aluminium grease filters
- Black



Also available

ESSCHIM70BK.1 70cm Chimney Hood

- Black

ESSCHIM90BK.1 90cm Chimney Hood

- Black

ESSCF15 Optional Carbon Filter Pack of 2



ESSCHIM100SS.1

100cm Chimney Hood

- Push button control
- 3 speeds
- Energy rating B
- Extraction rate 478.5m3/hr
- 66.3dB
- 2 LED lights
- 3 aluminium grease filters
- Stainless Steel



Also available

ESSCHIM100BK.1 100cm Chimney Hood

- Black

ESSCF16 Optional Carbon Filter Pack of 2



ESSCHIM110BK.1

110cm Chimney Hood

- Push button control
- 3 speeds
- Energy rating B
- Extraction rate 498m3/hr
- 66.3dB
- 2 LED lights
- 3 aluminium grease filters
- Black



Also available

ESSCHIM110SS.1 110cm Chimney Hood

- Stainless Steel

ESSCF16 Optional Carbon Filter Pack of 2



ESSRFCHIM60SS

Radio Frequency 60cm Hood

- 5 speeds plus intensive
- **Energy rating A+**
- 65dB
- Full touch control backlit glass fascia
- Extraction rate 530m3/hr
- Automatic timer
- LED linea lighting strip

Connects to the

ESSIH60P Hob &

ESSIH60PBZ Hob



Operation

- At initial set up stage the pairing process with the hob is completed via a combination of button presses
- Once paired the product operates via RF frequency thus ensuring a 100% reliable connection
- When in automatic mode the hood will regulate itself and adjust extraction speed dependent on the hob power used
- Auto timer function will regulate itself at the end of the cooking function and switch off the hood and light when complete
- Connectivity can be overridden at any time via one button press on the hob

ESSLED60SS/BK

60cm LED Curved Glass Chimney Hood

- Push buttons
- 3 speeds
- Energy rating B
- 66dB
- Extraction rate 320.4m3/hr
- 2 LED lights
- Illuminated glass with 3 colours
- 1 aluminium grease filter
- Stainless Steel or Black

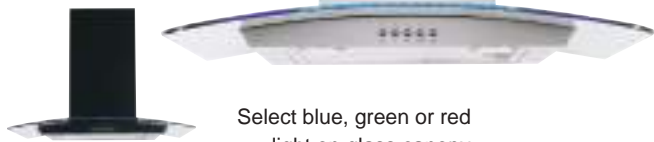

Select blue, green or red light on glass canopy



5" or 6"

Also available

ESSLED70SS/BK

70cm LED Curved Glass Chimney Hood

- Stainless Steel or Black

ESSLED90SS/BK

90cm LED Curved Glass Chimney Hood

- Stainless Steel or Black

ESSCF18 Optional Carbon Filter Pack of 2

ESSCG60SS.1/BK.1

60cm Curved Glass Chimney Hood

- Push buttons
- 3 speeds
- Energy rating C
- Extraction rate 296m3/hr
- 66dB
- 2 LED lights
- 1 aluminium grease filter
- Stainless Steel or Black



6"

Also available

ESSCG70SS.1/BK.1

70cm Curved Glass Chimney Hood

- Stainless Steel or Black

ESSCG90SS.1/BK.1

90cm Curved Glass Chimney Hood

- Stainless Steel or Black

ESSCF15 Optional Carbon Filter Pack of 2

ESSBX60SS.1

60cm Box Chimney Hood

- Touch control
- 3 speeds
- Energy rating A
- Extraction rate 515m3/hr
- 68dB
- 2 LED lights
- 2 aluminium grease filters
- Stainless Steel



Also available

ESSBX70SS.1 70cm Box Chimney Hood

- Stainless Steel

ESSBX90SS.1 90cm Box Chimney Hood

- Stainless Steel

ESSCF12 Optional Carbon Filter

5" or 6"

ESSFG60SS.1

60cm Flat Glass Chimney Hood

- Push button control
- 3 speeds
- Energy rating A
- Extraction rate 580m3/hr
- 67dB
- 2 lights
- 1 aluminium grease filter
- Stainless Steel



Also available

ESSFG70SS.1 70cm Flat Glass Chimney Hood

- Stainless Steel

ESSCF16 optional carbon filter pack of 2

5" or 6"

ESSISL90SS.1

90cm Island Hood

- 5 button soft touch control
- 3 speeds
- Energy rating D
- Extraction rate 640m3/hr
- 68dB
- 4 LED lights
- 2 aluminium grease filters
- Stainless Steel



6"

Also available

ESSISL90BK.1 90cm Island Hood

- Black

ESSCF16 Optional Carbon Filter Pack of 2



ESSTELBK

60cm Telescopic Hood

- Touch control
- 3 speeds
- Energy rating C
- Extraction rate 301m3/hr
- 64 dB
- 2 LED lights
- 1 aluminium grease filters
- Black



NEW

Also available

NEW ESSTEL90

90cm Telescopic Hood

- Rocker Control • Stainless Steel

ESSCF22 optional carbon filter pack of 2

6"

ESSINT.1

60cm Integrated Hood

- Slider control operation
- 3 speeds
- Energy rating D
- Extraction rate 350m3/hr
- 54dB
- 1 grease filter
- 1 light



ESSCF19 optional carbon filter

5"

ESSTEL

60cm Telescopic Hood

- Rocker control
- 2 speeds
- Energy rating E
- Extraction rate 340m3/hr
- 51 dB
- 2 lights
- 2 aluminium grease filters
- Stainless Steel



ESSCF7 optional carbon filter pack of 2

5"

Ducting Kits

ESSDK5 5 inch ducting kit

5"

ESSDK6 6 inch ducting kit

6"

ESSVIS.2

60cm Visor Hood

- Push button control
- 3 speeds
- Energy rating C
- Extraction rate 211.8m3/hr
- 71 dB
- 1 light
- 1 aluminium grease filter
- Stainless Steel



ESSCF21 optional carbon filter

5"

Stainless Steel Splashbacks

ESSSB60SS 60cm Splashback Stainless Steel

ESSSB70SS 70cm Splashback Stainless Steel

ESSSB90SS 90cm Splashback Stainless Steel

ESSCG Curved Hood S/Steel Splashbacks

ESSCSB60SS.1 60cm Curved Splashback S/Steel

ESSCSB70SS.1 70cm Curved Splashback S/Steel

ESSCSB90SS.1 90cm Curved Splashback S/Steel

ESSCG Curved Hood Black Splashbacks

ESSCSB60BK 60cm Curved Splashback Black

ESSCSB70BK 70cm Curved Splashback Black

ESSCSB90BK 90cm Curved Splashback Black

ESSLED LED Curved Hood S/Steel Splashbacks

ESSLEDCSB60SS 60cm Curved Splashback S/S

ESSLEDCSB70SS 70cm Curved Splashback S/S

ESSLEDCSB90SS 90cm Curved Splashback S/S

ESSLED LED Curved Hood Black Splashbacks

ESSLEDCSB60BK 60cm Curved Splashback Blk

ESSLEDCSB70BK 70cm Curved Splashback Blk

ESSLEDCSB90BK 90cm Curved Splashback Blk

ESSCAN52SS

52cm Canopy Hood

- 3 fan speeds
- Energy rating C
- 2 x 2W LED lights
- Slider control
- Suited to recirculate / vent
- Extraction rate: 200m3/hr
- 1 aluminium grease filter
- Silver



Also available

ESSCAN70SS

70cm Canopy Hood

- Silver

ESSCF19 optional carbon filter pack of 2

5"

ESSMWG17BS

17 Litre Microwave & Grill

- Integrated
- 700W microwave power
- Defrost function
- 245mm glass turntable diameter
- H: 388 x W: 595 x D: 300mm excl. fascia 320mm inc. fascia
- Stainless Steel



ESSMWG20SS

20 Litre Microwave & Grill

- Integrated
- 800W microwave power
- 1000W grill power
- LED green display
- 8 auto cooking programmes
- Defrost function
- Microwave / Grill combi cooking
- H: 382 x W: 595 x D: 320mm excl. fascia 340mm inc. fascia
- Stainless Steel



ESSMWNC20SS

20 Litre Microwave

- Integrated
- 800W microwave power
- Defrost function
- No clock
- 245mm glass turntable diameter
- H: 385 x W: 595 x D: 327mm excl. fascia 347mm inc. fascia
- Stainless Steel



ESSMW20BK

20 Litre Microwave

- Integrated
- 800W microwave power
- Defrost function
- 245mm glass turntable diameter
- H: 388 x W: 595 x D: 325mm excl. fascia 345mm inc. fascia
- Black



ESSMWG25BK

25 Litre Microwave & Grill

- Integrated
- 900W microwave power
- 1000W grill power
- LED white display
- 10 auto cooking programmes
- Defrost function
- Microwave / Grill combi cooking
- H: 388 x W: 595 x D: 385mm excl. fascia 410mm inc. fascia
- Black with Stainless Steel



ESS38MWG

38cm Microwave with Grill

- 20 litre capacity
- 8 auto programmes
- Defrost function • Quick start
- 800W microwave power
- 1000W grill power
- LED white display
- 255mm glass turntable • 13 amp plug
- H: 382 x W: 594 x D: 300mm excl. fascia 325mm inc. fascia
- Black with Stainless Steel



ESH5050.1

Built In 50/50 Fridge Freezer

- 148 ltr net capacity fridge
- 94 ltr net capacity freezer
- Energy rating F • 4 star freezer rating
- LED lighting • Auto defrost in fridge
- 4 fridge shelves, 1 salad crisper, 3 freezer drawers, 1 freezer flap
- Reversible door • Sliding hinge



2YR
PARTS
& LABOUR

ESH7030

Built In 70/30 Fridge Freezer

- 181 ltr net capacity fridge
- 68 ltr net capacity freezer
- Energy rating F • 4 star freezer rating
- LED lighting • Auto defrost in fridge
- 4 fridge shelves, 1 salad crisper, 2 freezer drawers, 1 freezer flap
- Reversible door • Sliding hinge



2YR
PARTS
& LABOUR

ESHLF177

Tall Larder Fridge

- 316 ltr net capacity
- Energy rating F
- Auto defrost
- 6 shelves, 2 salad crispers
- Adjustable thermostat
- LED lighting
- Reversible door • Sliding hinge



2YR
PARTS
& LABOUR

ESH5050FF

Built In 50/50 Frost Free Fridge Freezer

- 150 ltr net capacity fridge
- 78 ltr net capacity freezer
- Energy rating F • 4 star freezer rating
- Auto defrost in fridge • Frost free freezer
- 4 shelves, 2 salad crispers, 4 freezer drawers • Reversible door • Sliding hinge



2YR
PARTS
& LABOUR

ESH7030FF

Built In 70/30 Frost Free Fridge Freezer

- 190 ltr net capacity fridge
- 56 ltr net capacity freezer
- Energy rating F • 4 star freezer rating
- Auto defrost in fridge • Frost free freezer
- 5 shelves, 2 salad crispers, 3 freezer drawers • Reversible door • Sliding hinge



2YR
PARTS
& LABOUR

ESHFZ177

Tall Larder Freezer

- 200 ltr net capacity
- Energy rating F
- 9 drawers
- Adjustable thermostat
- 4 star freezer rating
- Reversible door
- Sliding hinge

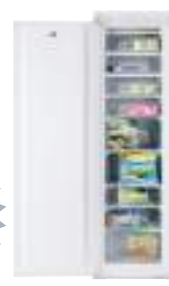

2YR
PARTS
& LABOUR

ESHLF60

60cm Built Under Larder Fridge

- 95 ltr net capacity
- Energy rating F
- 3 safety glass shelves, 1 salad crisper
- Auto defrost
- Adjustable thermostat
- LED lighting
- Reversible door



2YR
PARTS
& LABOUR

ESHFZ60

60cm Built Under Freezer

- 95 ltr net capacity
- Energy rating F
- 3 drawers
- Adjustable thermostat
- 4 star freezer rating
- Reversible door



2YR
PARTS
& LABOUR

ESHFRI60

60cm Built Under Fridge with Ice Box

- 95 ltr net capacity fridge
- 16 ltr net capacity ice box
- Energy Class F
- Auto defrost in fridge
- Safety glass shelves, 2 salad crispers
- Reversible door



2YR
PARTS
& LABOUR

ESHDW60

60cm Built In Dishwasher

- 13 place settings
- F rated
- 5 programmes including rapid wash
- Delay start
- 53dB
- 815mm high



ESHWM

Integrated Washing Machine

- **7kg load capacity**
- Digital LED display
- 14 programmes including 3 rapid wash options
- **Maximum spin speed 1400 rpm**
- Time delay up to 24 hour
- Extra rinse, Hygiene+ and Easy Iron options
- Add to wash / pause function
- Energy rating D



ESHDW45

45cm Built In Dishwasher

- 9 place settings
- F rated
- 5 programmes
- Delay start
- 52dB
- 816mm high



ESHWD

Integrated Washer Dryer

- **7kg wash, 5kg dry load capacity**
- Digital LED display
- 15 programmes including 3 rapid wash options
- **Maximum spin speed 1400 rpm**
- Time delay up to 24 hour
- Auto wash and dry cycles
- 3 sensor dry level options
- Add to wash / pause function
- Energy rating D/E



ESSDW60P.3

60cm Dishwasher with Cutlery Drawer

- Separate drawer for cutlery
- 14 Place Settings
- 7 wash programmes
- Energy rating E
- 49dB
- 815mm high



ESHCTD

Integrated Condenser Tumble Dryer

- **7kg dry load capacity**
- Full touch LED display
- 15 sensor drying programmes, plus Anti-crease
- Digital countdown indicator
- Delay start 24 hours
- Heat pump
- Energy rating A+



ESS60SS/BK

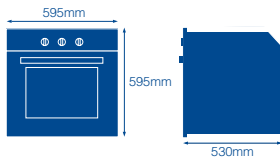

ESS60WH

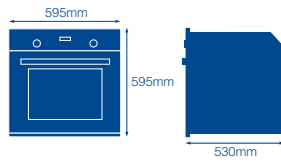

ESS61SS/BK

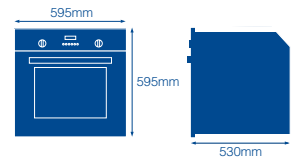

ESS62SS/BK

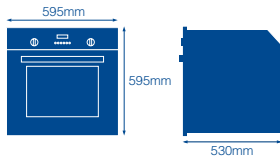

ESS50SS

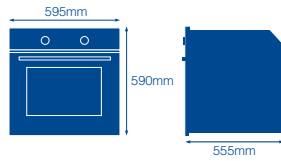

ESS63SS

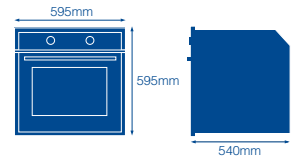

ESS64SS

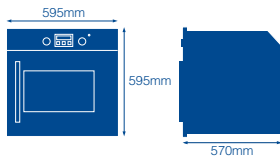

ESH90BK

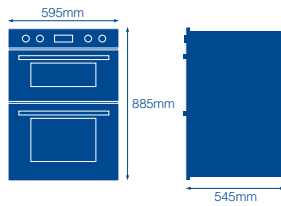

ESH70BK

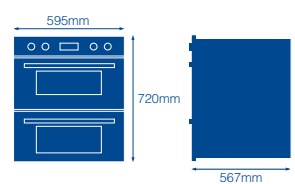

ESSMWG17BS

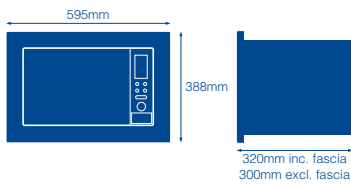

ESSMW20BK

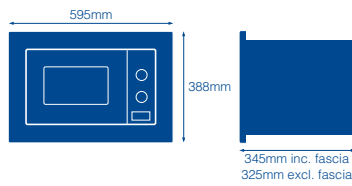

ESSMWG20SS

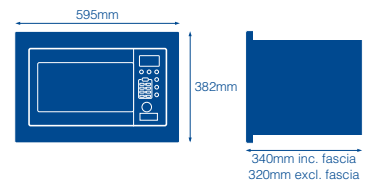

ESSMWNC20SS

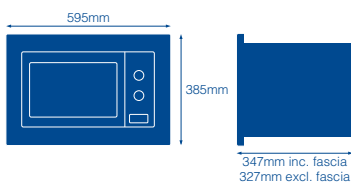

ESSMWG25BK

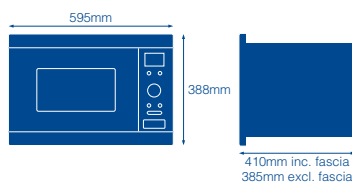

ESS38MWG

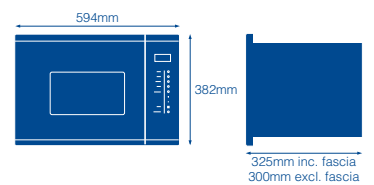

ESSIH50TC

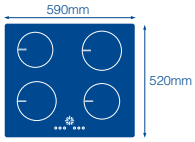

cut out size:
565mm wide x 495mm depth

ESSI60TC.1

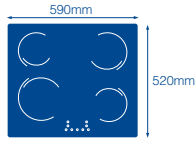

cut out size:
562mm wide x 490mm depth

ESSIH60P

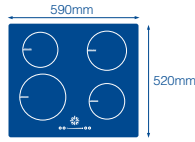

cut out size:
565mm wide x 495mm depth

ESSIH60PBZ

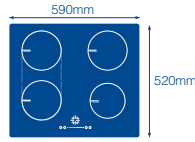

cut out size:
565mm wide x 495mm depth

ESSIH60W

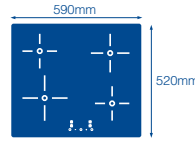

cut out size:
560mm wide x 490mm depth

ESSC60R.2

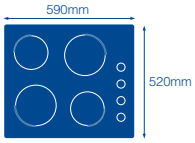

cut out size:
560mm wide x 490mm depth

ESSC60TC.1

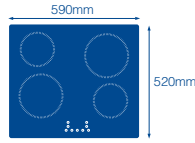

cut out size:
560mm wide x 490mm depth

ESSIH77

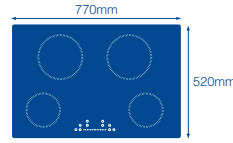

cut out size:
730mm wide x 490mm depth

ESSIH90

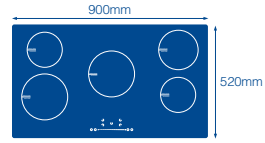

cut out size:
875mm wide x 495mm depth

ESSC75TC

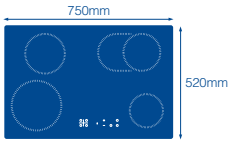

cut out size:
720mm wide x 490mm depth

ESSC90TC.1

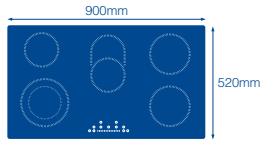

cut out size:
880mm wide x 490mm depth

ESSGG60

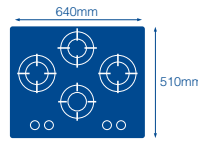

cut out size:
555mm wide x 475mm depth

ESSGGW60/W/GM

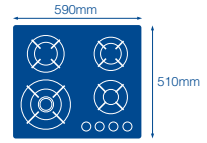

cut out size:
555mm wide x 475mm depth

ESSGGW64W

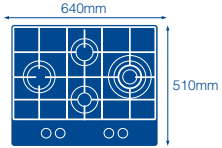

cut out size:
555mm wide x 475mm depth

ESSG60E

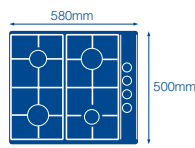

cut out size:
555mm wide x 475mm depth

ESSG60C

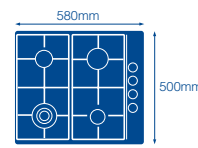

cut out size:
555mm wide x 475mm depth

ESSG70C

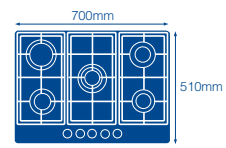

cut out size:
555mm wide x 475mm depth

ESHDW60

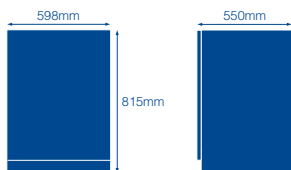

ESHDW45

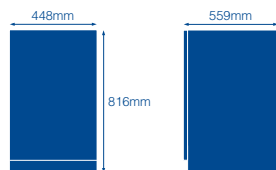

ESSDW60P.3

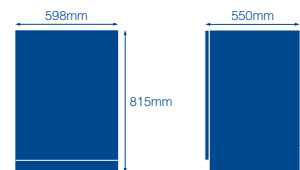

ESSISL90SS.1

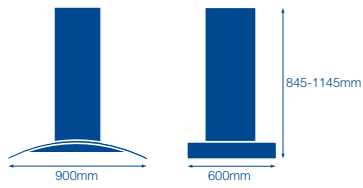

ESSISL90BK.1

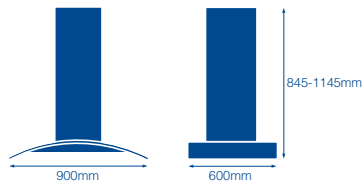

ESSCE90WH

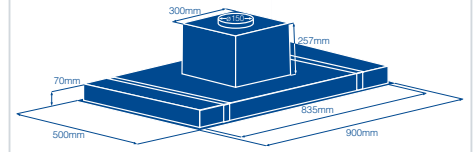

ESSANGP60BK

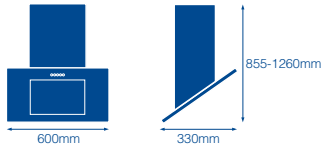

ESSANGP60SS

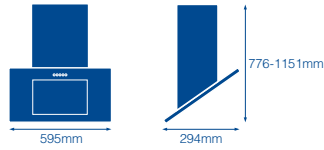

ESSANGP60

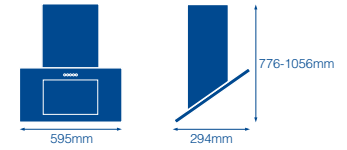

ESSRUN60BK

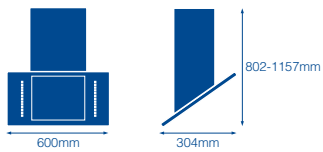

ESSRUN70BK

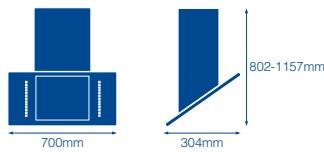

ESSRUN90BK

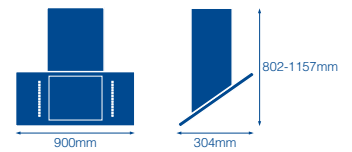

ESSBLUE60BK

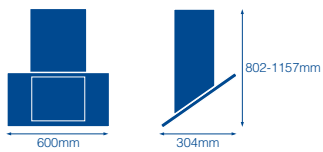

ESSBLUE70BK

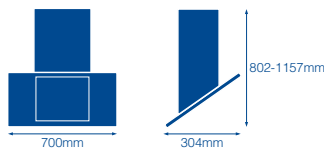

ESSBLUE90BK

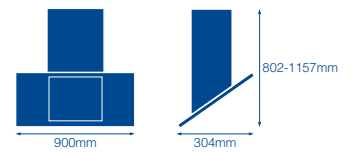

ESSCUR60BK

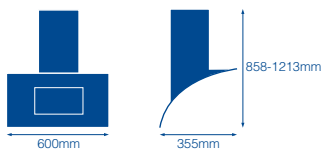

ESSCUR70BK

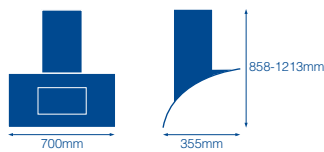

ESSCUR90BK

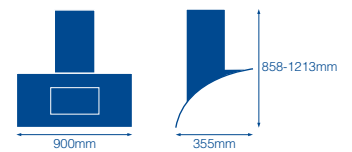

ESSANG60BK/WH

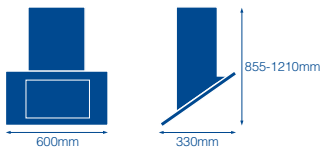

ESSANG70BK/WH

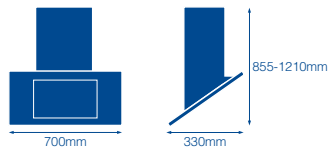

ESSANG90BK/WH

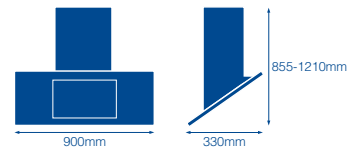

ESSLED60SS/BK

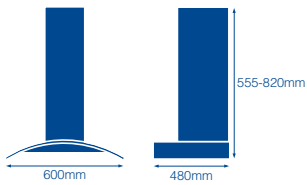

ESSLED70SS/BK

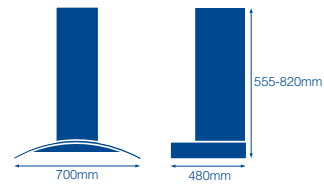

ESSLED90SS/BK

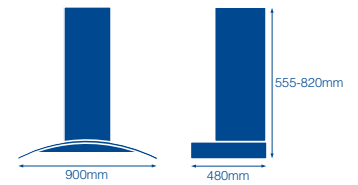

ESSCG60SS.1/BK.1

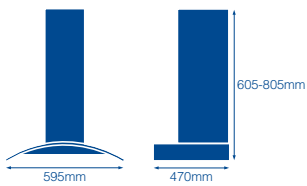

ESSCG70SS.1/BK.1

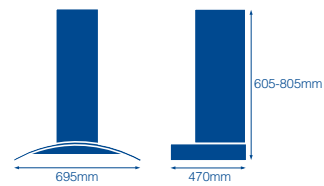

ESSCG90SS.1/BK.1

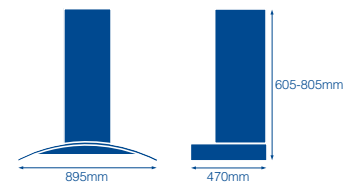

ESSCHIM60SS.2/BK.1

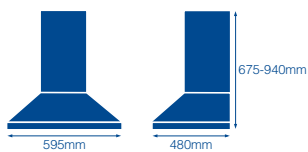

ESSCHIM70SS.1/BK.1

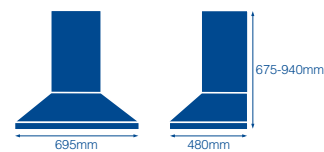

ESSCHIM90SS.1/BK.1

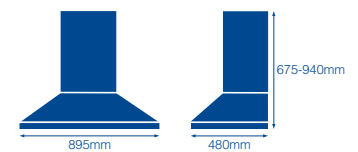

ESSCHIM100SS.1/BK.1

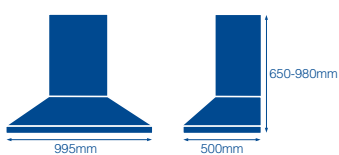

ESSCHIM110SS.1/BK.1

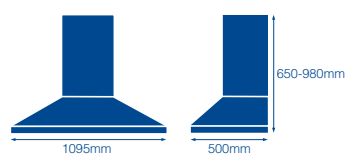

ESSRFCHIM60SS

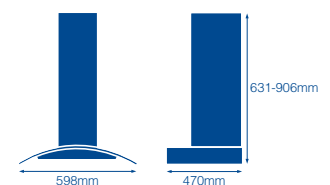

ESSBX60SS.1

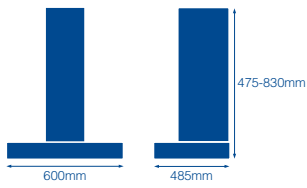

ESSBX70SS.1

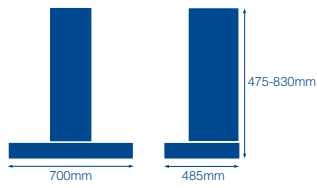

ESSBX90SS.1

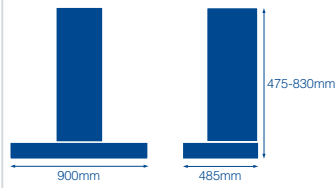

ESSTEL



ESSFG60SS.1

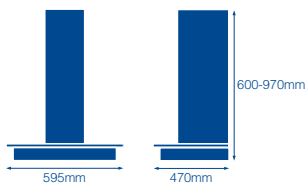

ESSFG70SS.1

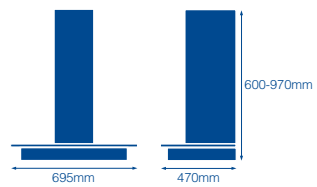

ESSCAN52SS

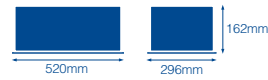

ESSTELBK



ESSVIS.2



ESSINT.1



ESSCAN70SS

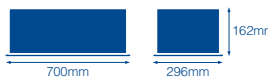

ESSTEL90

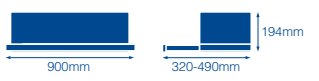

ESHWM

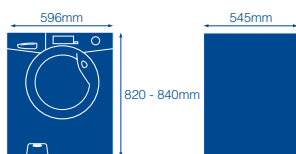

ESHWD

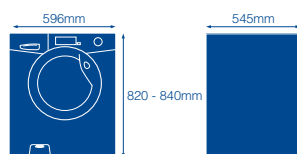

ESHCTD

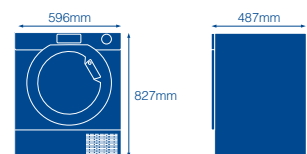

ESH5050.1

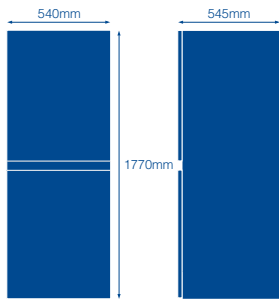

ESH5050FF

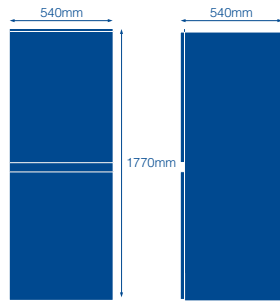

ESHLF60/ESHFZ60

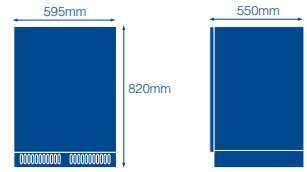

ESH7030

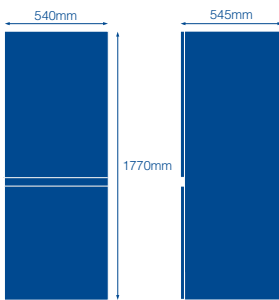

ESH7030FF

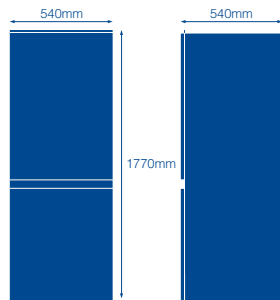

ESHFRI60

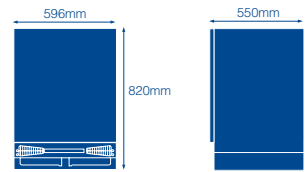

ESHLF177

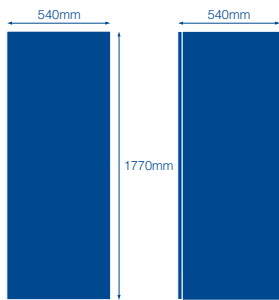

ESSWC150SS/BK

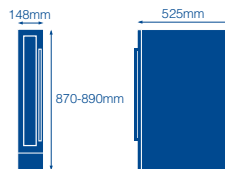

ESSWC300SS/BK

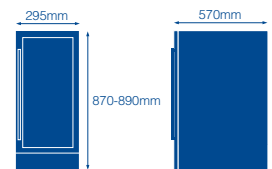

ESHFZ177

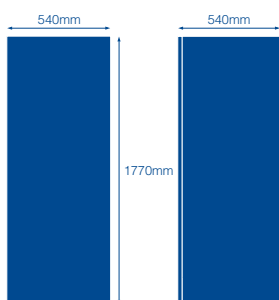

ESSWC600SS/BK

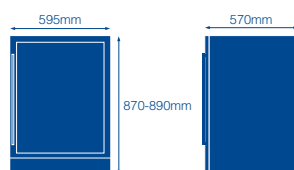

ESSWCTZ60SS/BK.1

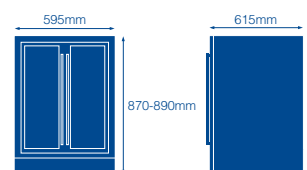

essentials

Including the premium+ range

November 2021

Please note, ESH - Cooking, Refrigeration and Laundry appliances featured in this brochure carry a 2 year parts and 2 year labour customer care guarantee, all other appliances carry a 5 year parts and 2 year labour customer care guarantee. Registration is required to qualify. For any service queries or to report a product fault please telephone the relevant service number below:

Service number for ESH - Cooking, Laundry, Dishwashing and Refrigeration appliances:

03444 995 599 (2 year parts, 2 year labour subject to registration).

Service number for Premium+ appliances: 0344 800 1128 (5 year parts, 2 year labour subject to registration).

Service number for all OTHER appliances including Wine Coolers and Cabinets:

0344 800 1128 (5 year parts, 2 year labour subject to registration).

Our policy is one of constant development and improvement. Whilst this is accurate at the time of printing, you are advised to check these specifications with the product. It is intended to help with your purchasing decision. It is not intended to replace the installation manual which provides more detailed information and should be disregarded if specification and/or appearances are changed in the interest of continuous improvement. All appliances featured in this brochure are CE marked as complying with the relevant appliance directives. All technical data is taken under laboratory conditions and may vary in use. Ratings are based on a 240v supply.

E&OE. November 2021.



THE CROWN IMPERIAL GROUP
WATERLINE 03330 149 149 www.waterline.co.uk

